

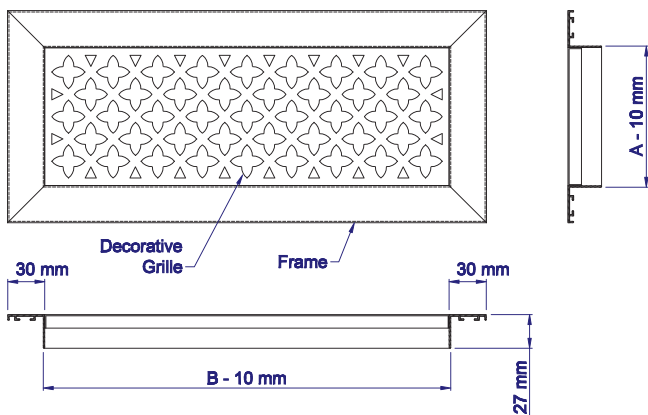

**Description:**

- Decorative grilles (architectural grilles) are available in several materials, gauges, colors and patterns/designs.
- Can be with rear set of blades for air deflection.
- Can be equipped with black opposed blade damper OBD for air flow fine tuning.



**DECORATIVE GRILLE WITHOUT DEFLECTION BLADES**

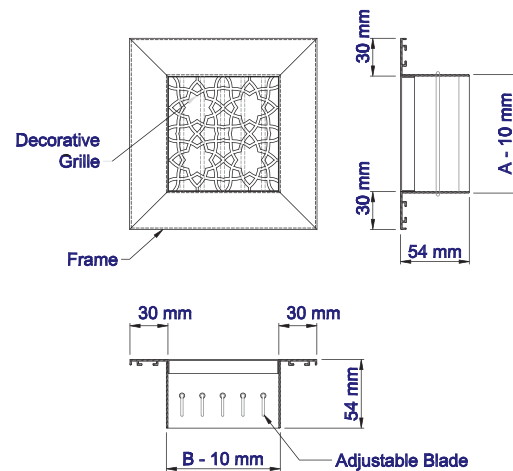

**DECORATIVE GRILLE WITH SINGLE DEFLECTION BLADES SET**

**Ordering Key:**

DEC	PI	A	I	G	S	SIZE
DECORATIVE	Pn: PATTERN/DESIGN NO. (1 - 18) PO: PATTERN/DESIGN BY CUSTOMER					
A: AL DECORATIVE SHEET G: GI DECORATIVE SHEET						
THICKNESS OF DECORATIVE SHEET: 1, 2 OR 3MM						
G: GRILLE (WITHOUT OBD) R: REGISTER (WITH OBD)						
-: WITHOUT DEFLECTION BLADES S: WITH SINGLE DEFLECTION						
SIZE: WIDTH X HEIGHT						



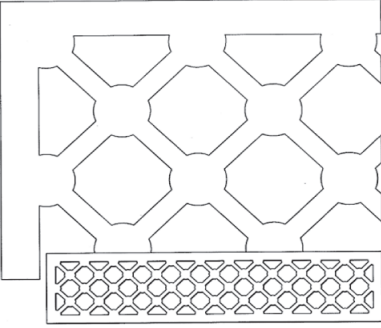
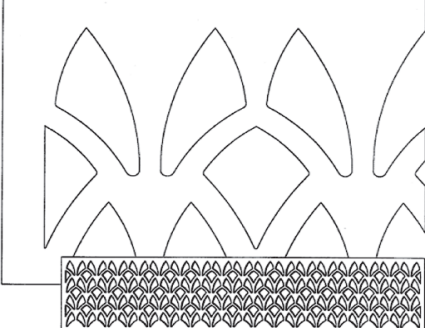
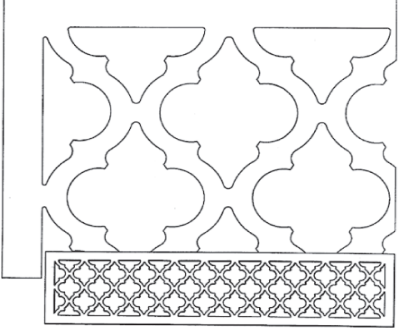
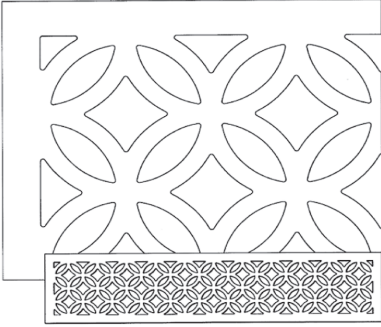
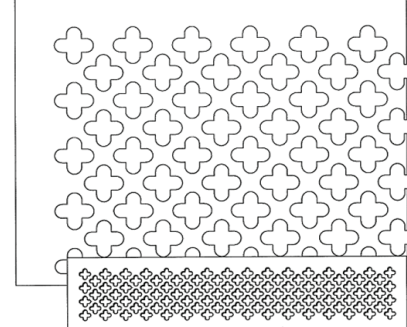
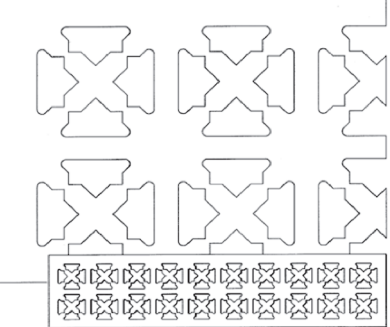
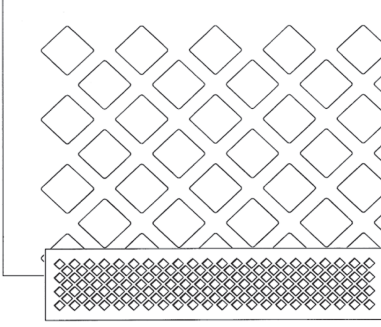
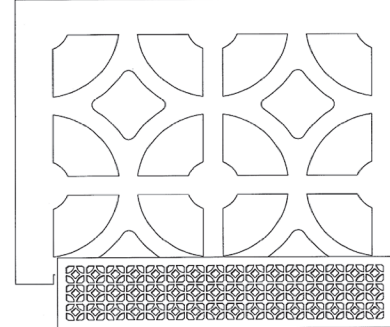
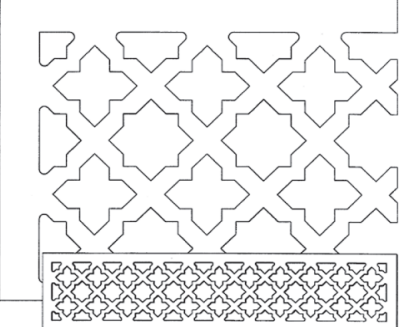

GRILLES & REGISTERS

 <p><b>PATTERN 1</b> 58% OPEN</p>	 <p><b>PATTERN 2</b> 57% OPEN</p>	 <p><b>PATTERN 3</b> 72% OPEN</p>
 <p><b>PATTERN 4</b> 40% OPEN <b>PATTERN 4A</b> 65% OPEN</p>	 <p><b>PATTERN 5</b> 51% OPEN <b>PATTERN 5A</b> 50% OPEN</p>	 <p><b>PATTERN 6</b> 45% OPEN <b>PATTERN 6A</b> 45% OPEN</p>
 <p><b>PATTERN 7</b> 53% OPEN <b>PATTERN 7A</b> 56% OPEN <b>PATTERN 7B</b> 64% OPEN</p>	 <p><b>PATTERN 8</b> 42% OPEN <b>PATTERN 8A</b> 55% OPEN</p>	 <p><b>PATTERN 9</b> 58% OPEN <b>PATTERN 9A</b> 58% OPEN</p>



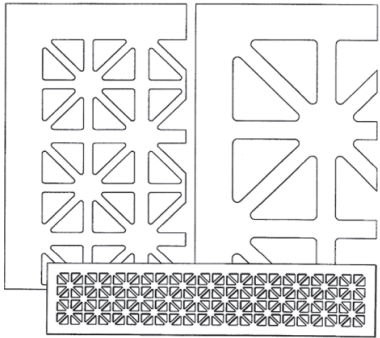
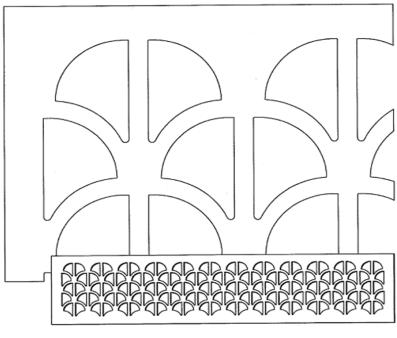
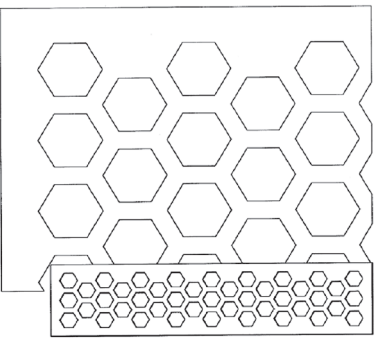
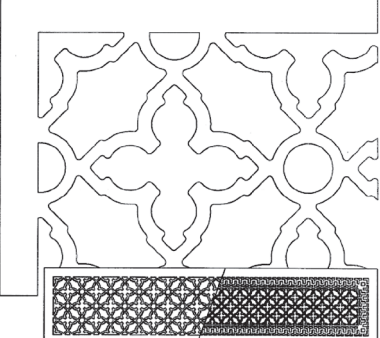
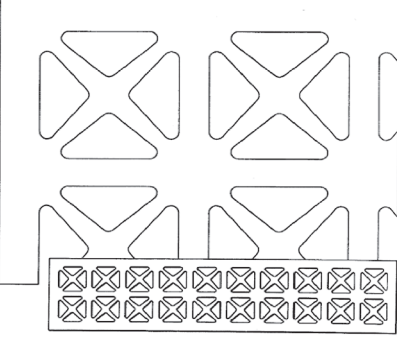
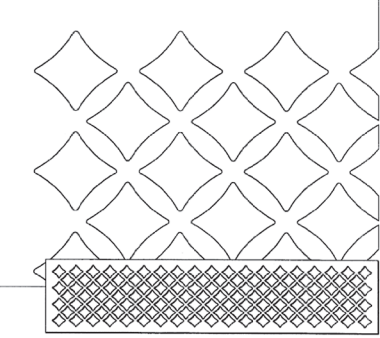
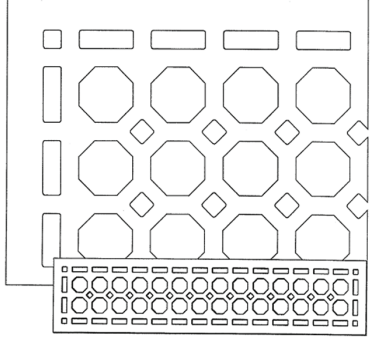
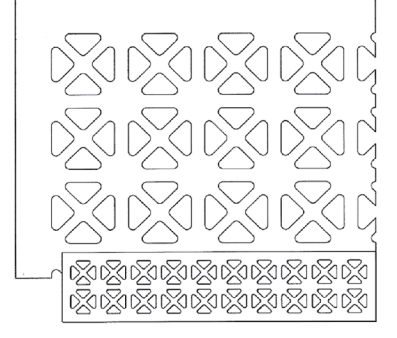
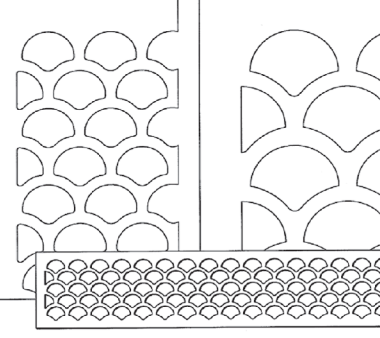

 <p><b>PATTERN 10</b> 40% OPEN</p> <p><b>PATTERN 10A</b> 49% OPEN</p> <p><b>PATTERN 10B</b> 50% OPEN</p>	 <p><b>PATTERN 11</b> 58% OPEN</p> <p><b>PATTERN 11A</b> 72% OPEN</p>	 <p><b>PATTERN 12</b> 56% OPEN</p>
 <p><b>PATTERN 13</b> 64% OPEN</p>	 <p><b>PATTERN 14</b> 41% OPEN</p>	 <p><b>PATTERN 15</b> 54% OPEN</p>
 <p><b>PATTERN 16</b> 55% OPEN</p> <p><b>PATTERN 16A</b> 53% OPEN</p>	 <p><b>PATTERN 17</b> 28% OPEN</p> <p><b>PATTERN 17A</b> 37% OPEN</p> <p><b>PATTERN 17B</b> 50% OPEN</p>	 <p><b>PATTERN 18</b> 59% OPEN</p> <p><b>PATTERN 18 A</b> 56% OPEN</p>

